

PRODUCT GUIDE



>Machine Vision

DATALOGIC

MACHINE VISION

The Machine Vision Business Unit of Datalogic Industrial Automation is built upon the acquisition of PPT Vision Inc. in 2011. For over 30 years, PPT Vision has focused exclusively on the development of machine vision technology for in-line automated inspection and factory automation. Thanks to its extensive experience of thousands of successful machine vision installations throughout the world, PPT has become a recognized world leader in machine vision innovation and has brought unique benefits to customers:

- **A single machine vision software platform** - Programming software that is flexible, powerful, and common to all smart cameras and embedded vision system products. This means no operator cross-training and no need to maintain different software platforms— just select the hardware you want and go! Transfer inspection programs from one camera to another and back again without redeveloping the application.
- **Flexibility and Security** - Control Panel Manager (CPM) - a control panel software that is not only secure, but field-configurable and common to all products. Protect your inspection and system configuration from unauthorized users, but allow qualified personnel as much flexibility as they need. CPM provides ultimate flexibility when compared to complicated software programming languages and allows you to create control panels in a mere fraction of the time. Connect and view data from one or many vision systems with just a click of a button.

- **Time-to-market** - Personalized, technically superior and committed customer support. We can provide you with as much support as you need when it comes to delivering application solutions. Choose one of our highly skilled and qualified application engineers or training specialists, or select a certified partner to guide you from application concept to installation and qualification of your system.
- **Large product portfolio** - Hardware platforms that allow our customers to expand their range of applications. From the simplest vision sensors to the highest performance embedded processors, we can deliver a vision system optimized for your inspection needs. Choose a smart camera in an inline or right angle version, color or greyscale sensor, CCD or CMOS sensor; it does not matter because we have you covered. For vision processors, select from a single to multi-headed area scan or line scan cameras that range from VGA to ultra-high resolution images.

Today, after completion of the integration process between Datalogic Industrial Automation and PPT Vision Inc., the combined product lines of the two companies encompass both hardware and software while covering a wide range of performance and price point requirements. Selling through a global network of experienced distributors and integration partners, Datalogic Automation is the complete solution provider for all your machine vision needs.

TECHNOLOGY TIMELINE

1982	1984	1991	1991	1994	1997	1997	2000	2001	2002	2002
Founded as Pattern Processing Technologies	APP 200 Series Vision System Introduced	Vision Process Controller (VPC) Product Released	Vision Program Manager (Classic) Software Released	PPT Vision releases the Passport Scout Product Lineup	PPT Acquires 3D Scanning Moiré Interferometry (SMI) Technology	DSL Vision System Introduced – World's First Full Digital Vision System	Microelectronics Product Group (MPG) Developed	PPT 861 3D Product released for Semiconductor Business	IMPACT C – Series Tethered Smart Camera Product Introduced	IMPACT Software Suite Released (Vision Program Manager & Control Panel Manager)

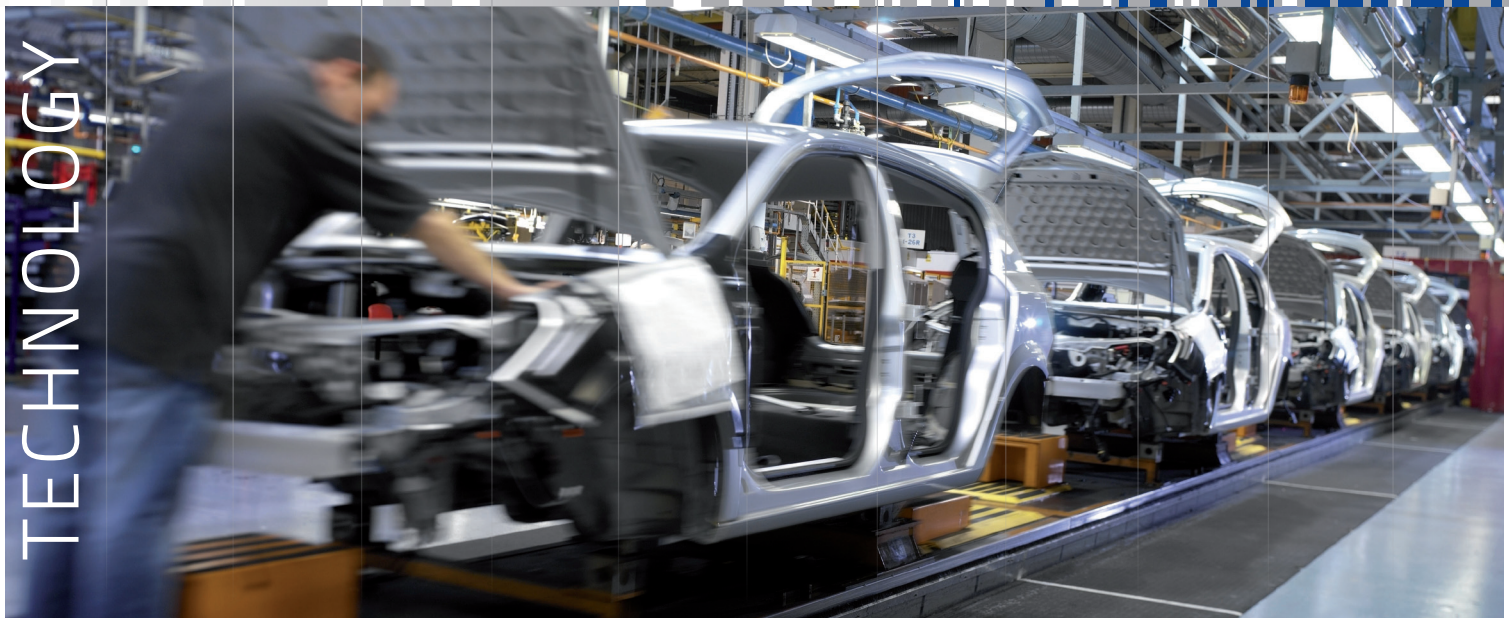

KEY BENEFITS

MACHINE VISION PRODUCT GROUP

- Vision Sensors
- Smart Cameras
- Vision Processors
- Machine Vision Software

Our complete family of high-performance smart cameras and embedded machine vision systems utilizes the same software across all products. The hardware consists of vision sensors, smart cameras, and embedded vision systems. These products are specifically designed and developed by our engineers to meet all your manufacturing inspection requirements and to get your application up and running faster than anyone else in the industry – Guaranteed!

INNOVATION

Through continuous development and refinement, our product line is the most complete hardware and software solution available on the market today.

EXPERIENCE

With 30 years in the machine vision business and thousands of successful customer installations, our organization and partners are able to solve the most challenging inspection applications within a wide variety of markets and manufacturing settings.

RESPONSIVENESS

Together with our global distribution and integration partners, pride our self on providing a level of training and support that is unmatched in the industry. We listen, then execute – turning our customers' requirements into solutions faster than anyone else.

2003

Integrates CameraLink into C-Series Processor

2003

OCR Software Released

2004

IMPACTT – Series Inline Smart Camera Introduced

2005

Datalogic SCS1 Smart Camera Introduced

2006

IMPACT A – Series Right Angle Smart Camera Introduced

2007

Datalogic DataVS Vision Sensor introduced

2010

MX40 Multi camera vision processor Introduced

2010

New Improved Pattern Finding Software Released

2011

PPT Vision acquired by Datalogic

2012

PPT Vision Inc. becomes the Machine Vision BU of Datalogic Industrial Automation



VISION SENSORS



DATA VS2

Machine vision is now closer than ever to photoelectric sensors thanks to DataVS2 series.

DataVS2 vision sensors feature a built-in illuminator and integrated optics to offer maximum compactness and installation simplicity.

The wide range of controls together with the easy-to-use Graphical User Interface allows the user to solve simple machine vision applications in a quick and effective way.

DataVS2 is available in four versions with different software features:

- DataVS2 Object Recognition (OB)
- DataVS2 Advanced Object Recognition (AOR)
- DataVS2 Identification (ID)
- DataVS2 Professional (PRO)

DataVS2 is the right solution when standard photoelectric sensors are not able to meet application requirements and represents a cost-effective and easy-to-use alternative to traditional vision systems.



HIGHLIGHTS

- Wizard based configuration software
- Versatile PC setup and emulator functionality
- Ethernet communication capability
- 360° Pattern Match
- Barcode and Datamatrix readers
- Monitoring and tuning available through a remote monitor (VSM) with no PC

APPLICATIONS

- Logo Check
- Product / Part presence and orientation
- Label position
- Component Counting
- Data & Lot Code Presence

ELECTRONIC

The T4x-Series product is a high performance, ruggedized smart camera that can address most single camera inspection needs.

The T4x-Series product incorporates high quality CCD imagers, a class rating of IP67 and the latest in high performance processors. This makes it perfectly suited for the demands of high density pin inspections in the automotive and telecom industries. These connectors require not only verification of pin presence, but also high precision measurements across, potentially, several hundred pins and key feature locations.

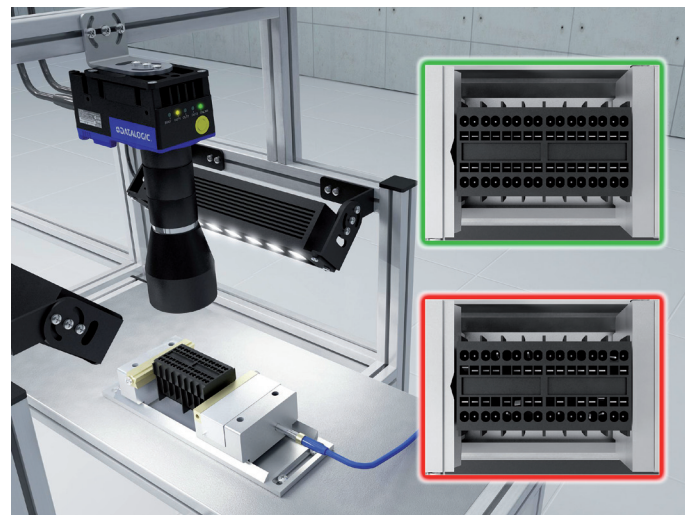

SMART CAMERAS



A/T SERIES

The A and T-Series smart camera products are standalone, general-purpose, industrialized machine vision inspection systems that allow for incredible flexibility in programming through the Impact software.

With models ranging from standard VGA resolution up to 5 Megapixels, the A and T-Series smart cameras can deliver the right solution for your general-purpose machine vision needs or specific application inspection requirements.

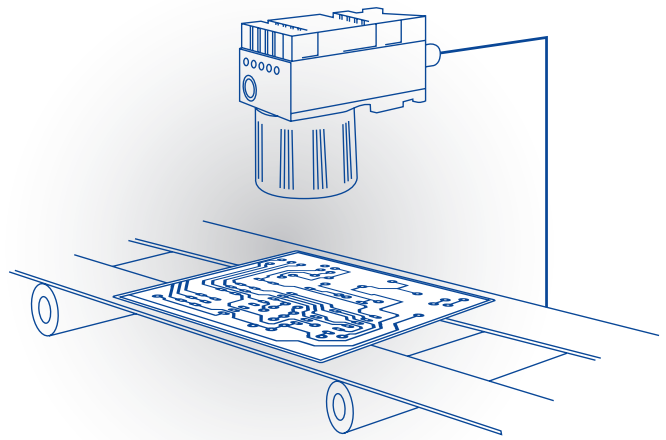
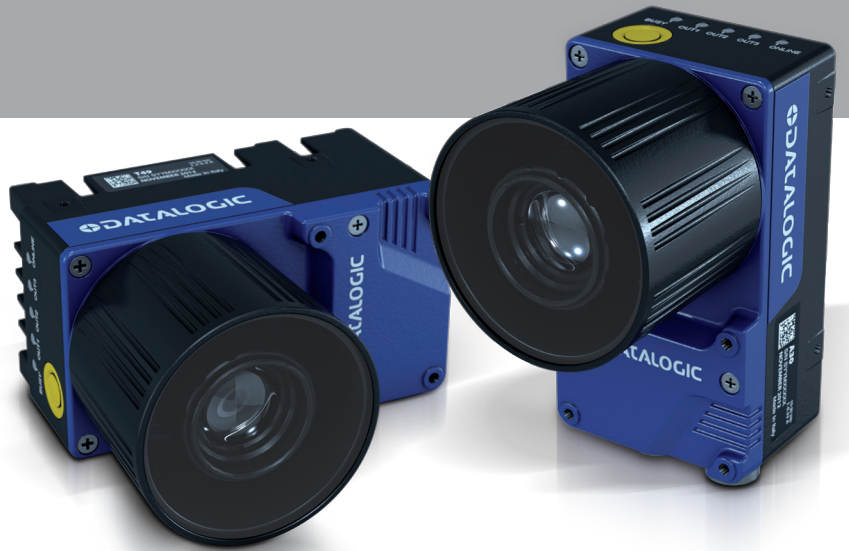

HIGHLIGHTS

- Real time operating system for accurate results
- Full machine vision capability and programmability – not a configurable sensor
- Can run headless or provide data to PCs
- Industrially hardened enclosure - up to IP67 rating
- Full serial and Ethernet communication capability
- Built in discrete I/O
- 90 Degree and in-line camera formats

APPLICATIONS

- Lot Code Verification
- Optical Character Recognition (Reading Product Serial Numbers)
- Precision Repeating Measurements (Measuring Integrated Circuit Contacts)
- Plastic Molding Short Shot Detection (Carrier Tape Inspection)
- Pattern Finding (Locating and Identifying Product Orientation)
- Color Verification and Sorting (Color Cap Inspection)

MEDICAL

The M-Series vision processor product line up provides you with the most image processing performance in a fully integrated vision system. With multi-core processors, these systems can handle the most demanding high-speed and multi-camera applications, such as hypodermic needle inspection. The needle application shown here requires the system to image and verify needle length, straightness, and epoxy presence from three different cameras, while a fourth camera checks for grinding defects at the end of the needle. This inspection is being performed at seventeen needles per second.

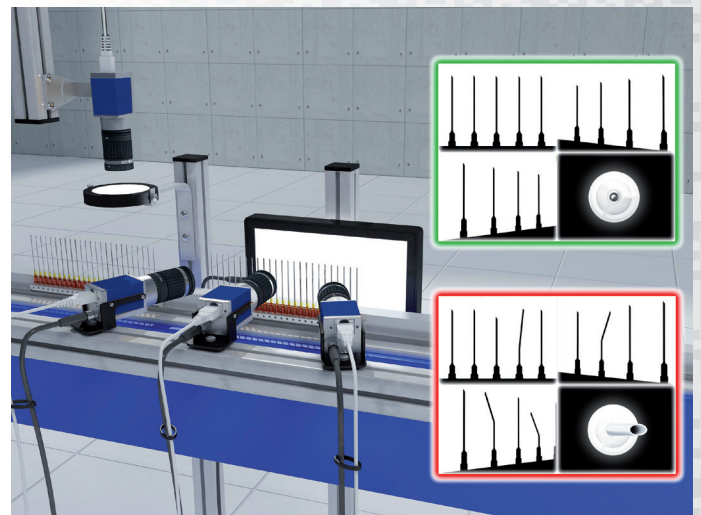

VISION PROCESSORS



MX-SERIES

Vision processors provide the highest performance in image processing with even more flexibility through multi-camera support.

Connect to multiple camera formats at one time (e.g. area scan, line scan, high resolution, 3 CCD, etc. on same processor) via GigE Vision standards.

Three models allow you to choose the correct level of performance based on your application needs – from economical to high performance.

HIGHLIGHTS

- Three levels of high-powered image processing capability
- Seamless integration with standard factory networks and secondary software packages
- Over 100 different GigE Vision cameras supported, including line scan
- Use different cameras formats and resolutions on one processor
- Complete software tool set for ultimate programming flexibility
- Place cameras a long distance apart
- No need for a secondary PC to view or retain images and inspection data

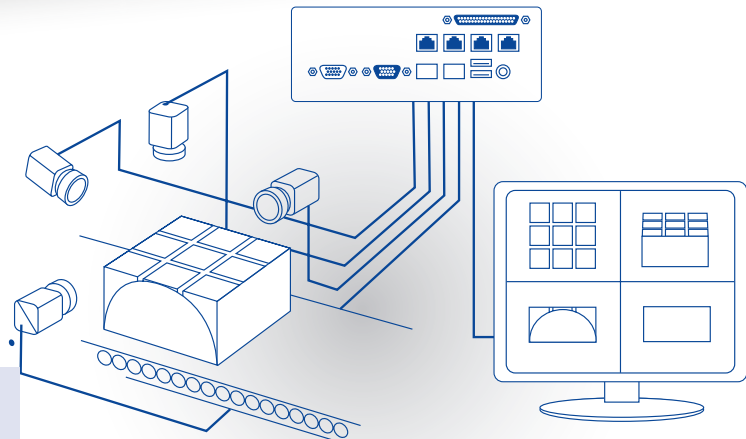

APPLICATIONS

- High-Resolution Image Analysis (LCD Panel Inspection)
- High-Speed Product Inspection (Web or Continuous Part Inspection)
- Multi-Camera Inspection (Hypodermic Needle Inspection)
- Line scan Applications (Automotive or Telecom Connector Inspection)
- Image Unwrapping (Code Reading on Circular Objects)
- High-Resolution Color Analysis (Color Matching Inspection)

AUTOMOTIVE

The A-Series smart camera provides the perfect balance of size, functionality, and pricing to easily support a multitude of tasks, including the verification of objects within an assembly. In this case, the system assures that all of the bearings are in place regardless of position or actual number found. The result is image and data output to the user interface and, at the same time, signals to a reject device.

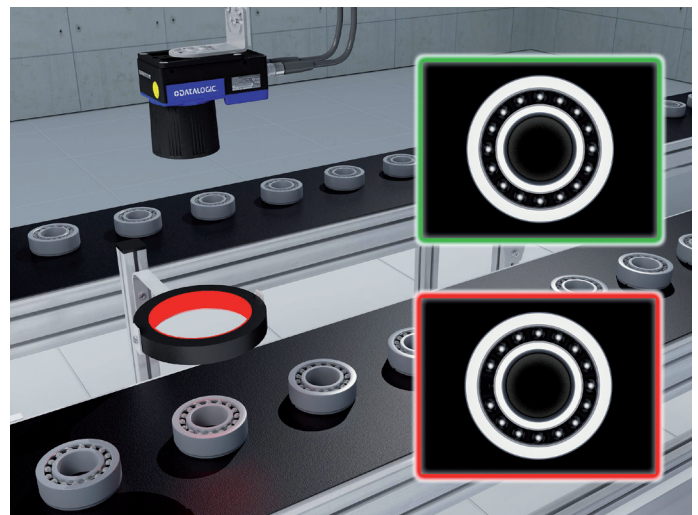

MACHINE VISION SOFTWARE



IMPACT SOFTWARE

Impact Software Suite, with over 120 software tools and controls, allows you to create unique inspection programs and develop user interfaces quickly and easily.

All this can be done without the loss of functionality, like traditional configurable systems, or the need for vast amounts of development time like traditional SDK environments.

One software – countless applications!



HIGHLIGHTS

- Graphical icon-based drag and drop user interface – no programming required
- Easy to understand, tree-view logic flow
- Tool Setups guide users through step-by-step tool configuration
- Includes inspection and user interface development programs as well as a runtime user interface
- Runs on all smart camera and vision processor platforms
- Provides complete programmatic or manual control of hardware settings
- Provides real time parameter changes of cameras
- Controls and displays images and data from multiple smart cameras or vision processors
- Password protection allows only authorized users to make changes

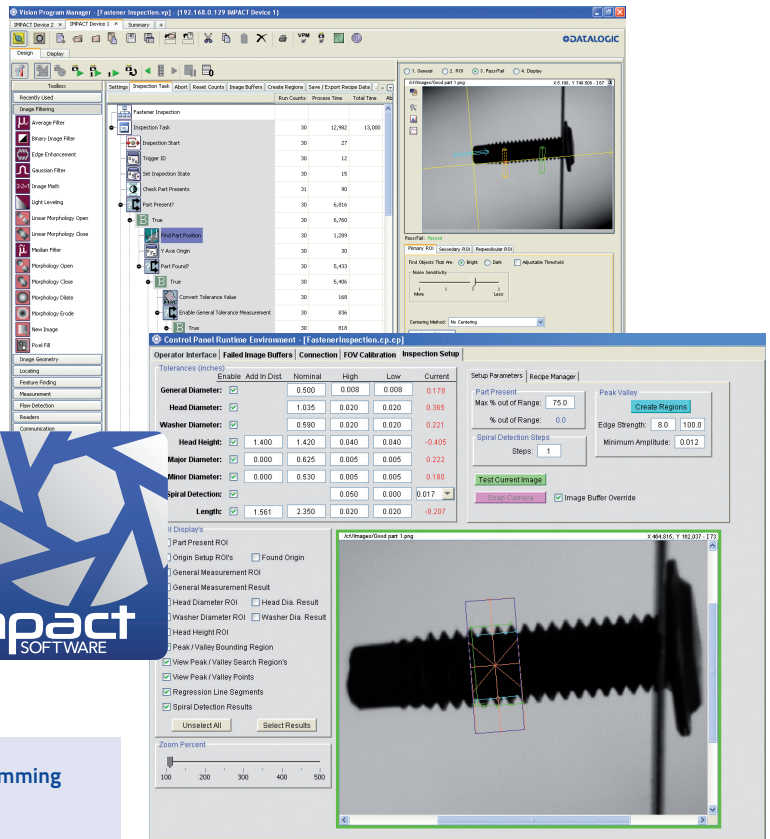

VISION PROGRAM MANAGER (VPM) CONTROLS:

- Image Filtering
- Locating
- Defect Finding
- Gauging
- Data and Communication
- Code Reading
- Color

CONTROL PANEL MANAGER (CPM) CONTROLS:

- Image Control
- Inspection Result Data
- Advanced GUI Development Support
- Communications
- Security Controls

FOOD PACKAGING

Thanks to its intuitiveness, ease-of-use and cost-effectiveness, DataVS2 allows you to develop reliable quality inspections with outstanding Return On Investment. The wide range of controls can easily solve several applications such as presence/absence, part position and orientation as well as label inspection. In the example, DataVS2 detects the presence of the expiration date printed on pizza packages thus guaranteeing the maximum product quality and traceability. Moreover, thanks to the use of VSM, the operator can easily monitor the device behavior and change the running inspection when a product changeover occurs.



HEADQUARTERS

Datalogic Automation Srl

Via Lavino, 265
40050 Monte San Pietro - Bologna - Italy
Tel. +39 051/6765611
Fax +39 051/6759324
info.automation.it@datalogic.com

BRANCHES AND SALES OFFICES

EUROPE

BENELUX

Datalogic Automation Benelux

Newtonweg 3
4104 BK Culemborg
The Netherlands
Tel. +31 345/589489
Fax +31 345/511419
info.automation.nl@datalogic.com

FRANCE

Datalogic Automation Srl

Succursale en France
Le Parc Technologique de Lyon
333 cours du 3ème Millénaire - Le Pôle
69800 Saint Priest
Tél. +33 (0)4/72476180
Fax +33 (0)4/72470721
info.automation.fr@datalogic.com

GERMANY

Datalogic Automation Srl

Niederlassung Central Europe
Carl-Zeiss Str. 31
73230 Kirchheim/Teck
Tel. +49 (0)7021/509700
Fax +49 (0)7021/5097029
info.automation.de@datalogic.com

ITALY

Datalogic Automation Srl

Via Lavino, 265
40050 Monte San Pietro - Bologna
Tel. +39 051/6765611
Fax +39 051/6759324
info.automation.it@datalogic.com

Datalogic Automation Srl

LASER MARKING

Via Le Gorrey, 10
11020, Donnas - Aosta
Tel. +39-0125-8128201
Fax +39-0125-8128401
info.automation.it@datalogic.com

Via Dell'Industria 20, 21018
Sesto Calende - Varese
Tel. +39-03319180601
Fax +39-03319180801
info.automation.it@datalogic.com

SPAIN

Datalogic Automation Iberia

Sucursal en España
C/ Samontà, 21 Planta baja, Local 0
08970 Sant Joan Despí - Barcelona
Tel. +34 (0)93/4772059
Fax +34 (0)93/477272
info.automation.es@datalogic.com

NORDIC

Datalogic Automation AB

Höjdrodergatan 21
21239 Malmö - Sweden
Tel. +46 (0)40/385000
Fax +46 (0)40/385001
info.automation.se@datalogic.com

UNITED KINGDOM

Datalogic Automation UK

Datalogic House
Dunstable Road, Redbourn - Hertfordshire
AL3 7PR
Tel. +44 (0) 1582 791750
Fax +44 (0) 1582 791769
info.automation.uk@datalogic.com

NORTH AMERICA

Datalogic Automation Inc

511 School House Road
Telford, PA 18969-1196 - United States
Tel. +1-800-BAR-CODE or +1-215-723-0981
Fax +1-215-721-5551
info.automation.us@datalogic.com

Datalogic Automation Inc

MACHINE VISION

6301 Old Shakopee Road
Minneapolis, MN 55438 - United States
Tel. +1-952-996-9500
Fax +1-952-996-9501
info.automation.us@datalogic.com

APAC

AUSTRALIA-NEW ZEALAND

Datalogic Automation Pty Ltd

Unit 130, 45 Gilby Road
Mt Waverley - Victoria, 3149 - Australia
Tel. +61 (0)3/95589299
Fax: +61 (0)3/95589233
info.automation.au@datalogic.com

CHINA

Datalogic Automation Asia

Floor 20, Room 2017, Building 2,
16 West Nan San Huan Road
Fengtai District, Beijing
Tel: +86 (0)21-5836 6692
Fax: +86 (0)21-5836 6695
info.automation.cn@datalogic.com

Suite 1301, Hua Rong Plaza,
1289 South Pudong Road, Pudong District
Shanghai 200120
Tel: +86 (0)21-5836 6692
Fax: +86 (0)21-5836 6695
info.automation.cn@datalogic.com

Room 1104B, 5#Tower, Fantasta MIC
Plaza, West Nanhai Road, Nanshan
District,
518054 Shenzhen, Guangdong, China
Tel: +86 (0)755-8629 6779
Fax: +86 (0)755-8628 1280
info.automation.cn@datalogic.com

JAPAN

Idec Datalogic Co. Ltd

10-40, Mikuni-Honmachi 1-Chome,
Yodogawa-ku, Osaka 532 0005
Tel. +81(6) 6398/3200
Fax +81 (6) 6398/3202
www.idljp.com

Rev. 04, 07/2013



9C511200E



 **DATALOGIC**

www.datalogic.com